

おなじ なかまの かたちを せんで つなぎましょう。

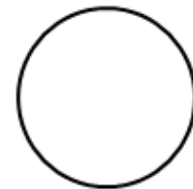

おなじ なかまの かたちを せんで つなぎましょう。

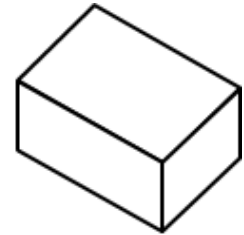
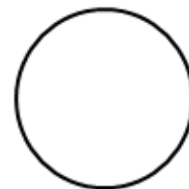
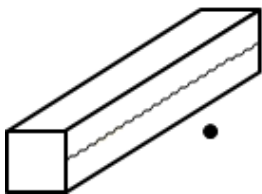
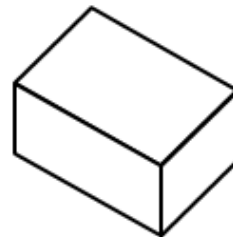
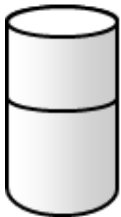

はこや つつを うつして かたちを かきます。  
どのかたちに なりますか。せんで つなぎましょう。

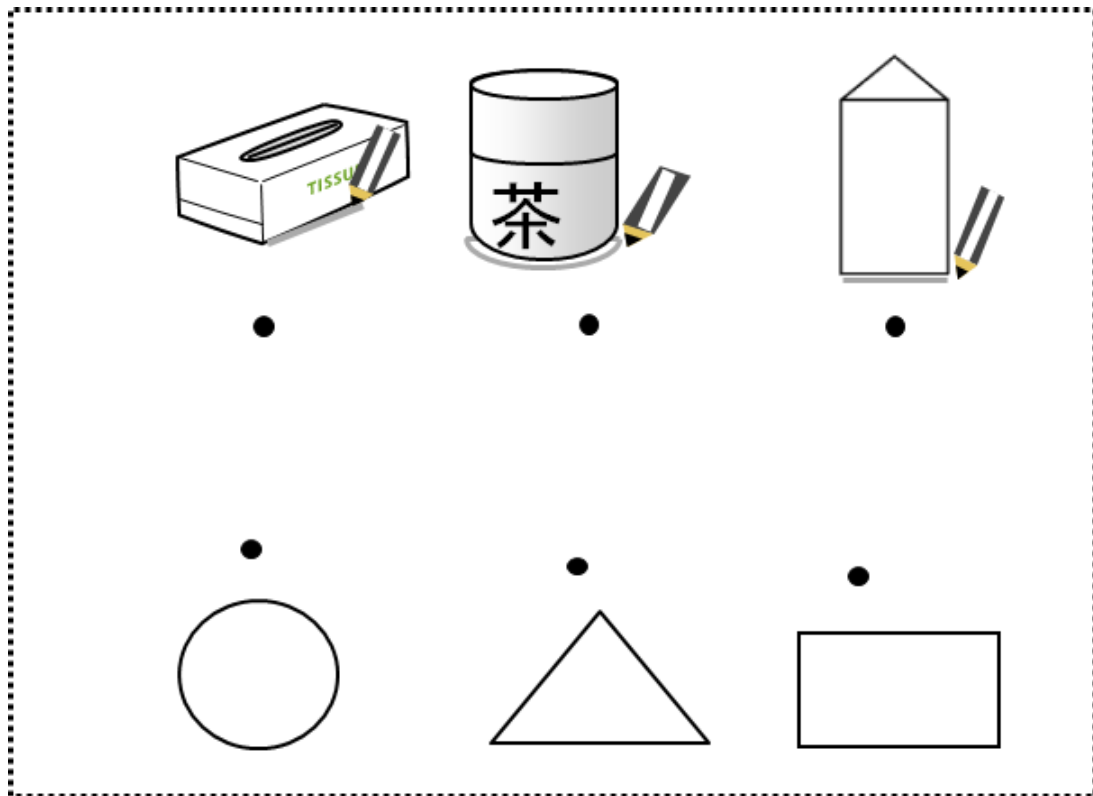

つみきの かたちを うつして かたちを かきます。  
どの つみきから うつしたのでしょうか。  
せんで つなぎましょう。

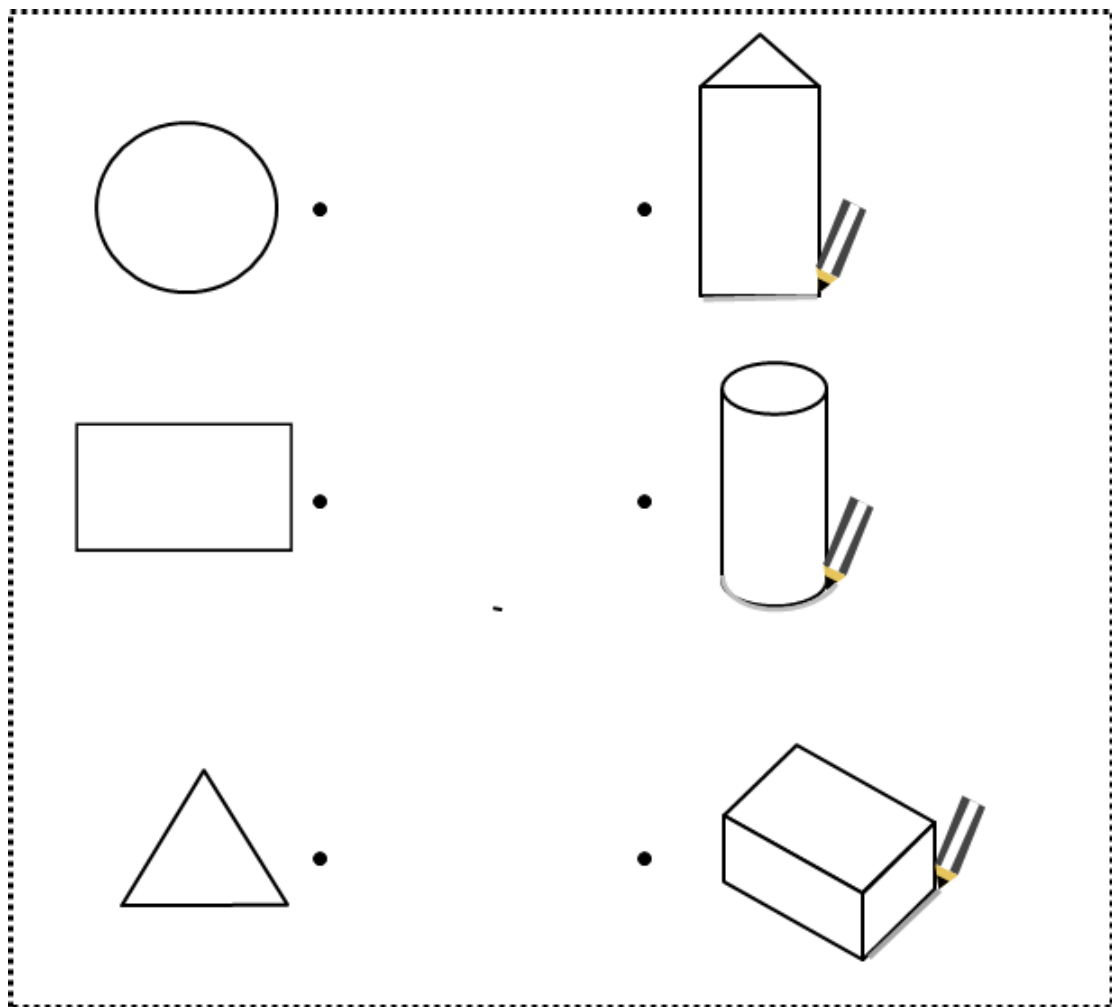

1. おなじ なかまの かたちを せんで つなぎましょう。

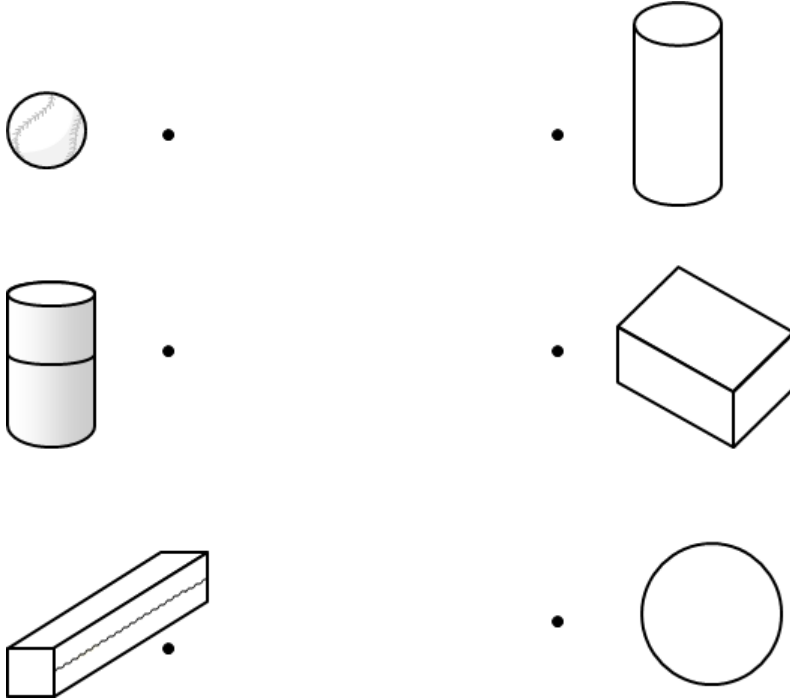

2. はこや つつを うつして かたちを かきます。どのかたちになりますか。せんで つなぎましょう。

